

# J2EE-Based Systems Development and Oracle9i JDeveloper

**transentia**

Wednesday, October 09, 2002



Bob Brown  
*Transentia Pty. Ltd.*  
[bob@transentia.com.au](mailto:bob@transentia.com.au)  
<http://www.transentia.com.au>

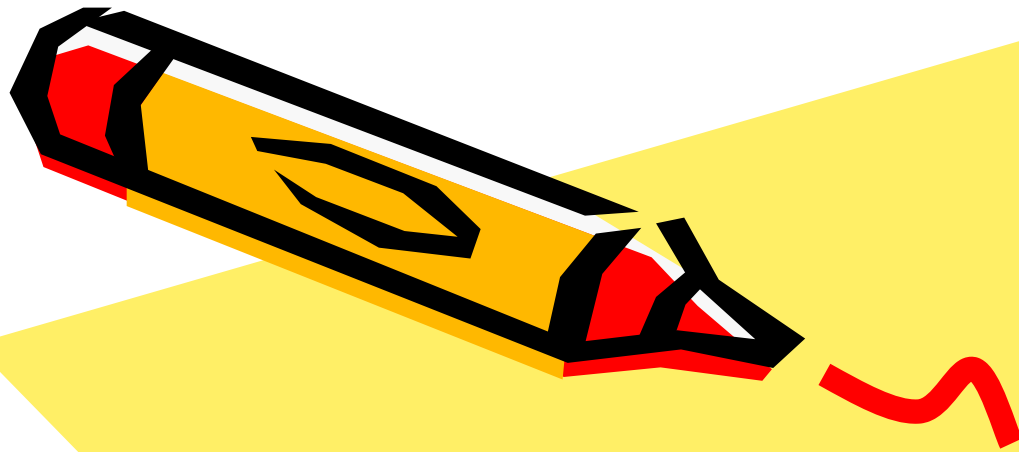
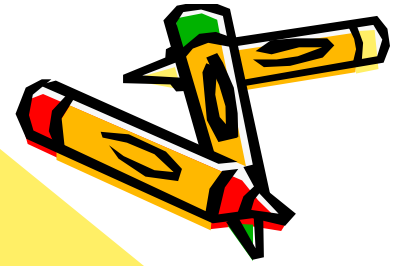

# The J2EE Component Technologies

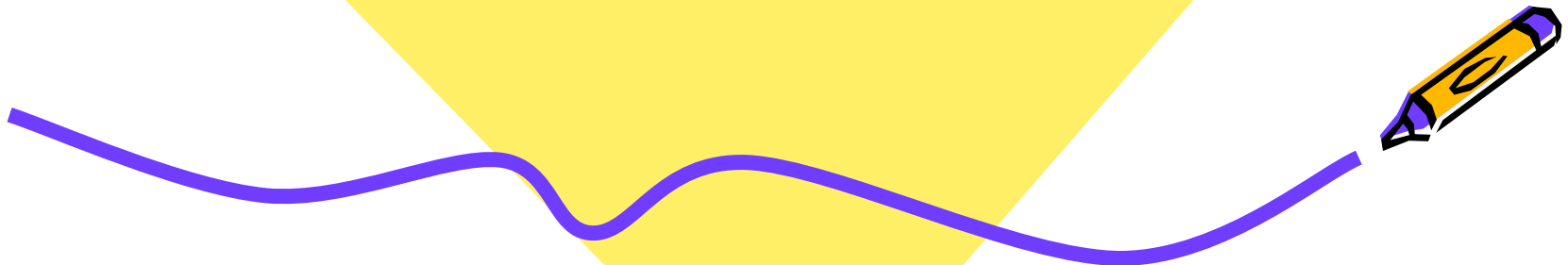

# J2EE

- Java 2, Enterprise Edition

- A story to join the Java technologies together
- Server-centric
- Integration-oriented
- Component-oriented
- Simpler
  - N.B. *not* simple!
- Tool focussed
- Web-centric
- Cross-platform
  - As much as Java is, anyway...
- Churning on Internet timescales

*"The J2EE platform represents a single standard for implementing and deploying enterprise applications. ... the J2EE platform is designed to provide server-side and client-side support for developing enterprise, multitier applications."*

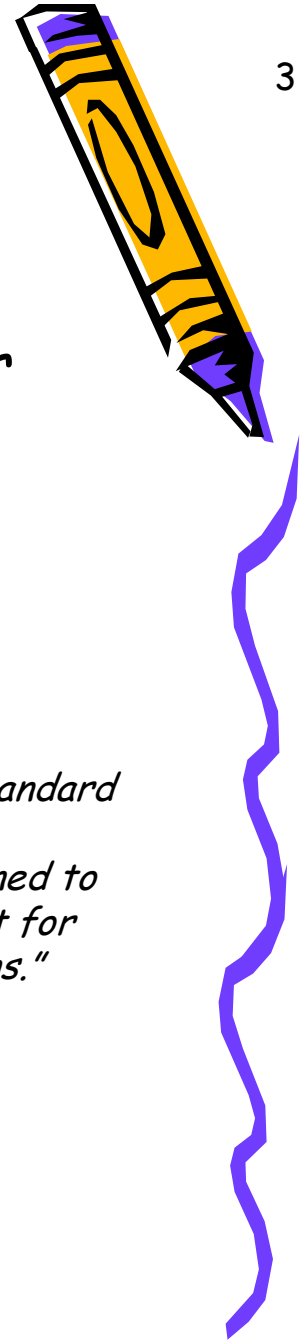

# Alphabet Soup

- JDBC
  - Database connectivity
- JNDI
  - Naming/Directory services
- JAAS
  - Authorisation/Authentication infrastructure
- JMS
  - Messaging Oriented Middleware
- JTA/JTS
  - Transaction handling
- JMX
  - Application management and monitoring
- Servlets
  - Handles web-based client interactions
- JSP
  - Template API to Servlet mechanism
- Taglibs
  - Component/tool API for JSPs

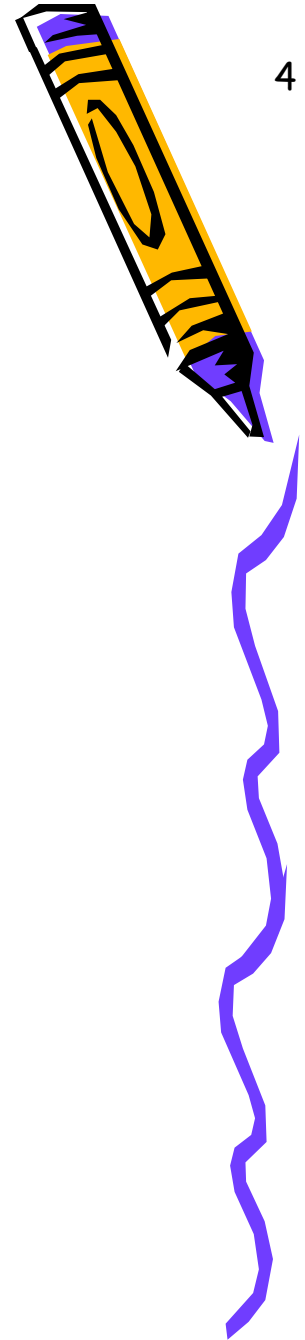

# Alphabet Soup...

- EJBs
  - Framework for enterprise-grade components
- JAXP
  - XML manipulation
- JWS
  - Simplified deployment of Java applications to a desktop
- WebServices
  - XML-based messaging between components
    - An end to the "interoperating object wars"?
    - A way for Object interactions to pass through the firewall at last?
- JCA
  - High-level EIS integration
- JavaMail/JAF
  - Internet email/messaging
- RMI
  - Remote Method Interaction protocol
- Container
  - Life support module for components such as Servlets/JSPs/EJBs

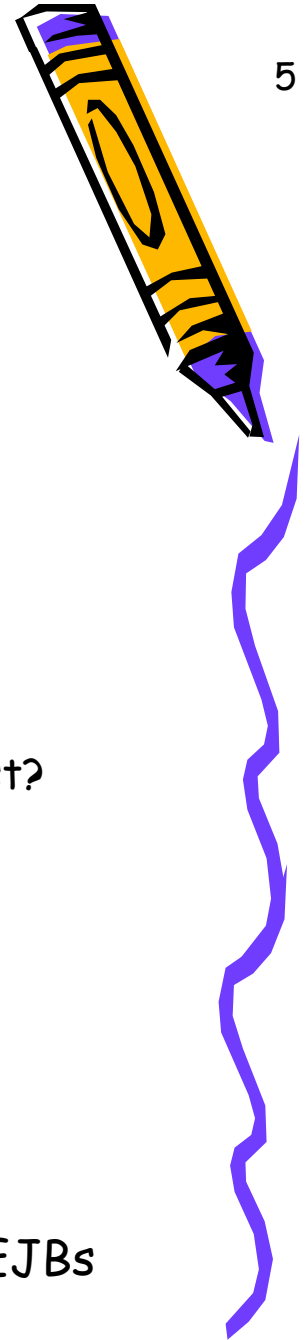

# Architecture(s)

- All the pieces of the puzzle

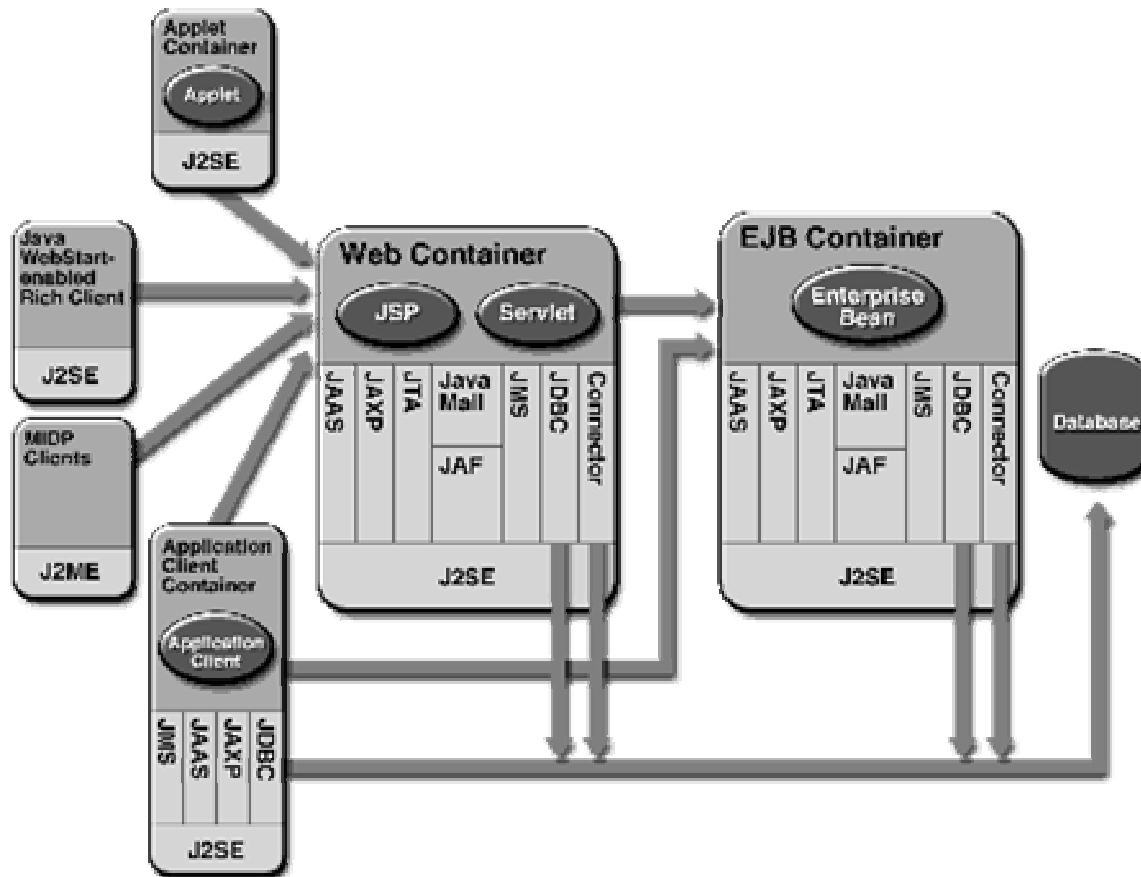

[http://java.sun.com/blueprints/guidelines/designing\\_enterprise\\_applications\\_2e/technologies/technologies2.html](http://java.sun.com/blueprints/guidelines/designing_enterprise_applications_2e/technologies/technologies2.html)

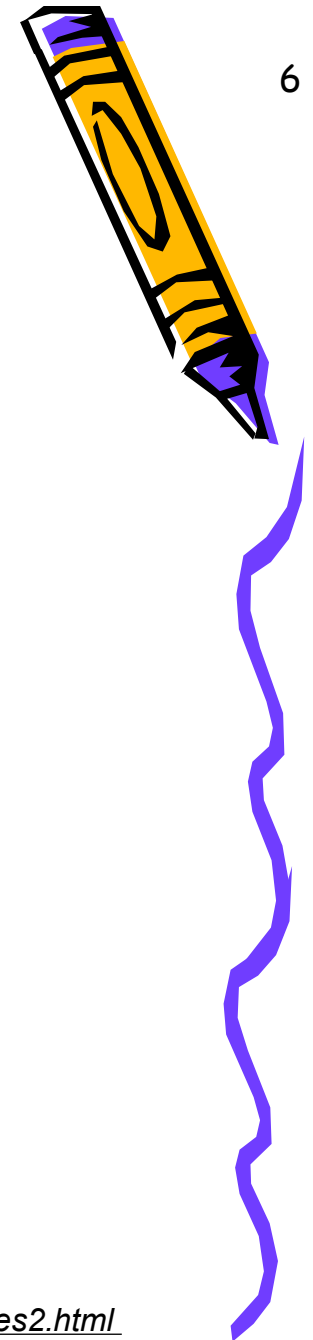

# Patterns

- Patterns underpin much of what the J2EE is about, i.e.:
  - Model/View/Controller (MVC)
  - Data Access Objects
  - Session Façade
  - Value Object
  - Page-by-Page Iterator
  - Fast-Lane Reader
- Give a common language for describing a problem and (hopefully) identifying a common solution

*"A design pattern describes a proven solution to a recurring design problem, placing particular emphasis on the context and forces surrounding the problem, and the consequences and impact of the solution"*



# MVC

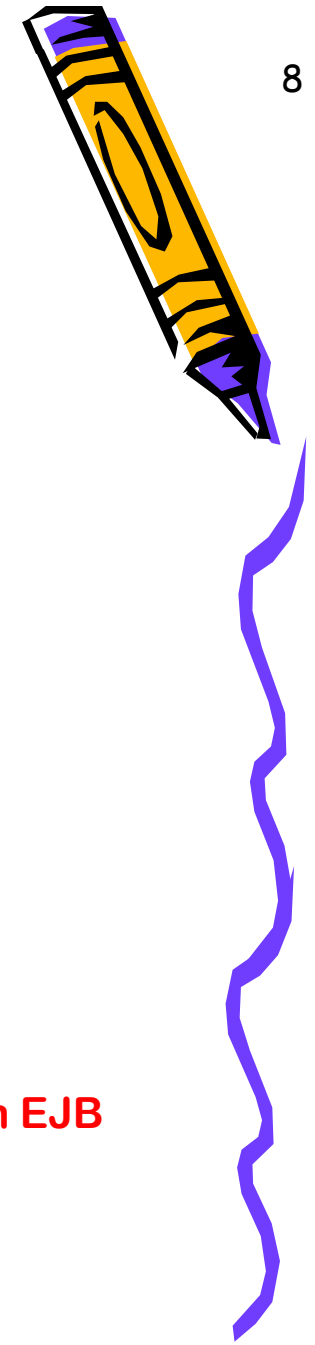

- Model-View-Controller
  - Design architecture underpinning J2EE

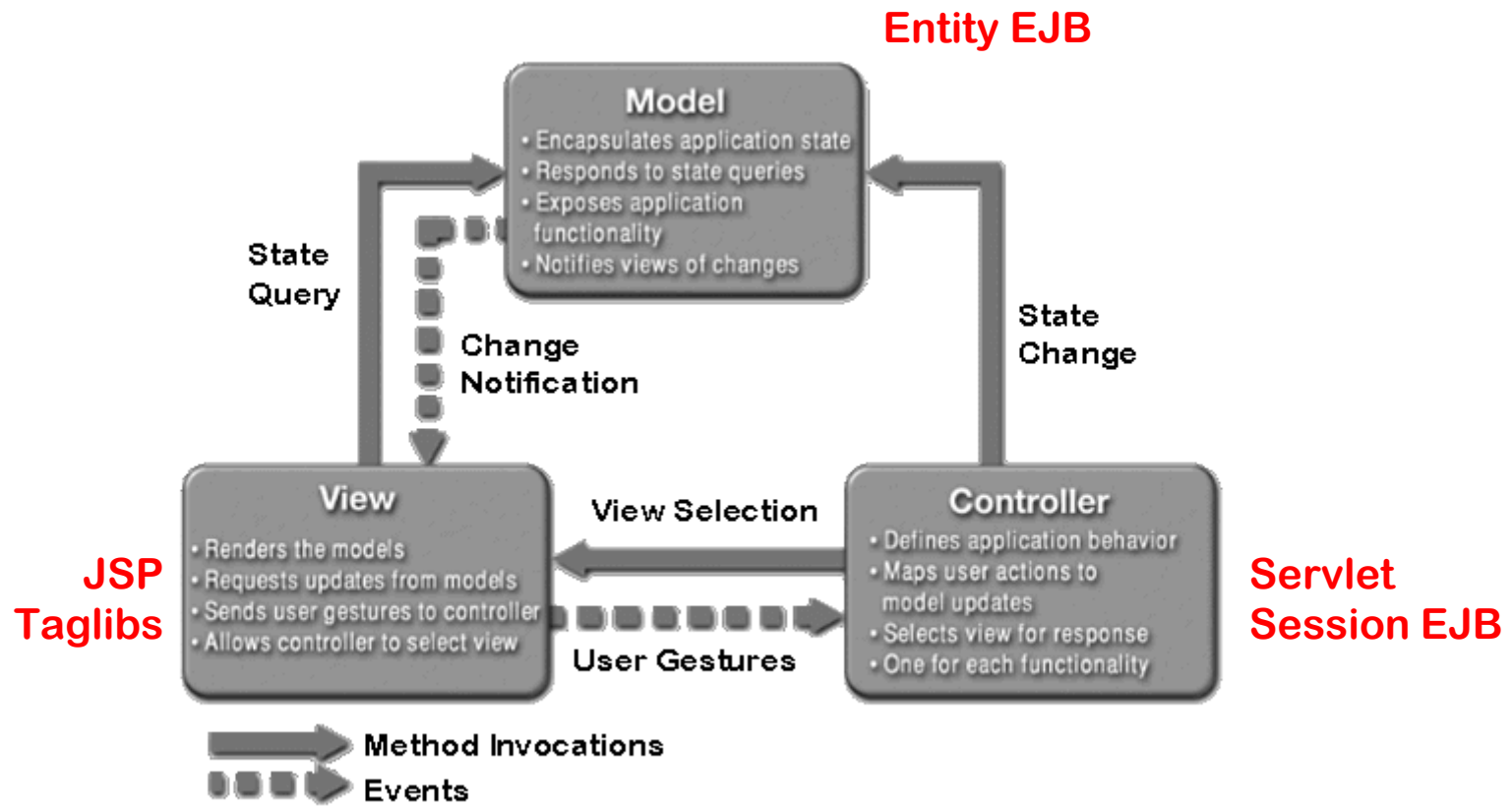



# IDEs

- A major focus of the J2EE technologies
  - Several not solely "for human consumption"
    - Taglibs, EJBs...
  - A burgeoning marketplace
    - JDeveloper, Together/J, WebLogic Workshop, JBuilder, Netbeans/Forte, Eclipse, IDEA,...
  - A 'difficult' marketplace
    - Getting *hard* to charge \$\$\$ for an IDE
      - Getting hard to charge \$ for an IDE!

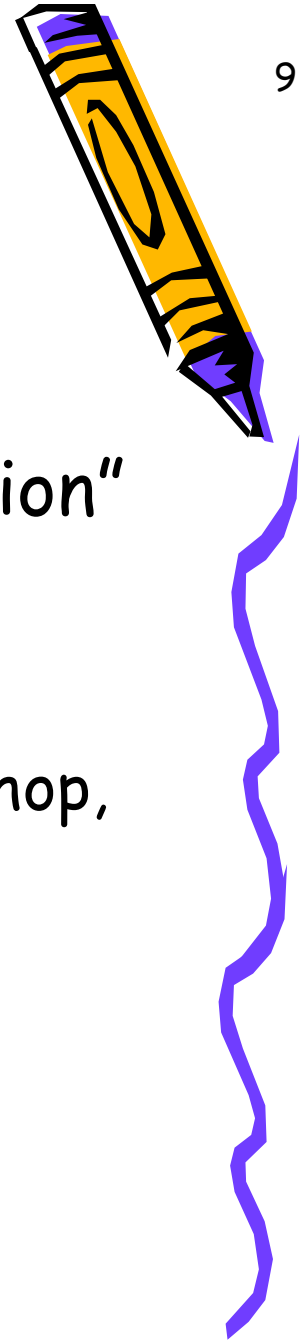

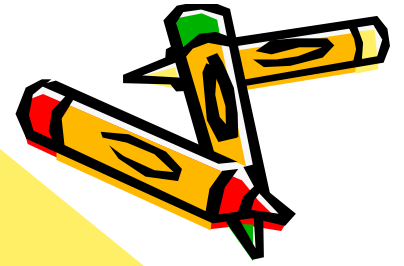
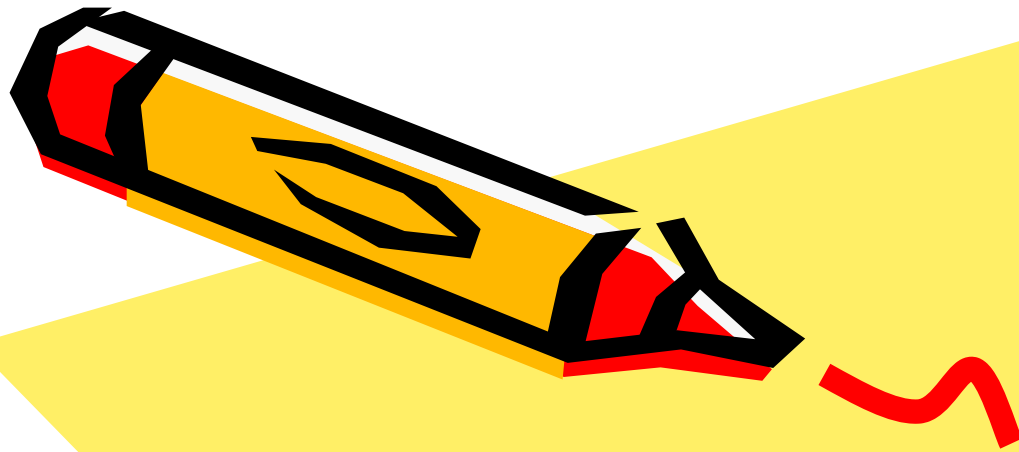

# J2EE Development with Oracle9i JDeveloper

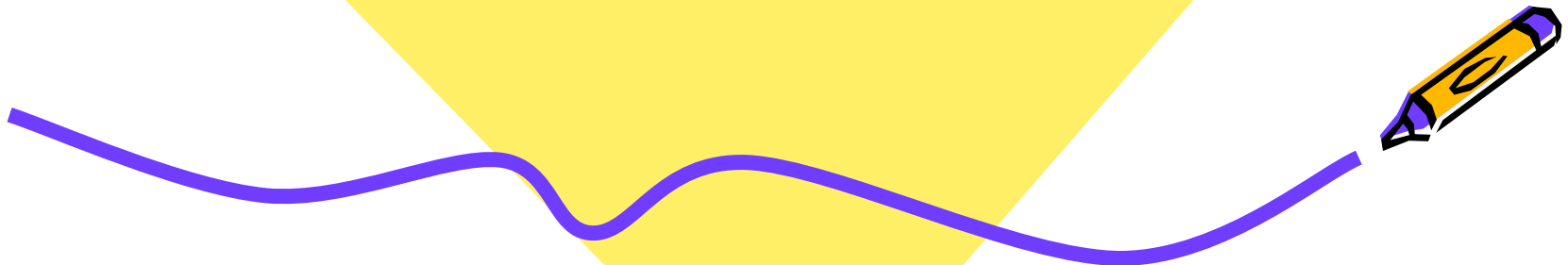

# JDeveloper 9i

- Introduced May 2002
- Oracle's flagship IDE
  - Free download; ~US\$995 for commercial/support license
- Complete re-write from JDeveloper 3
  - No longer a re-badged JBuilder
- Extensive feature set
- Quite standards-oriented
  - But with lots of Oracle goodies to make life easier
  - Will be revised regularly as standards evolve

*"Oracle believes strongly, and has invested heavily, in the combination of Java, SQL, and XML. Java is used for programming the business and presentation logic, SQL for interacting with the database, and XML for passing information between loosely coupled applications."*

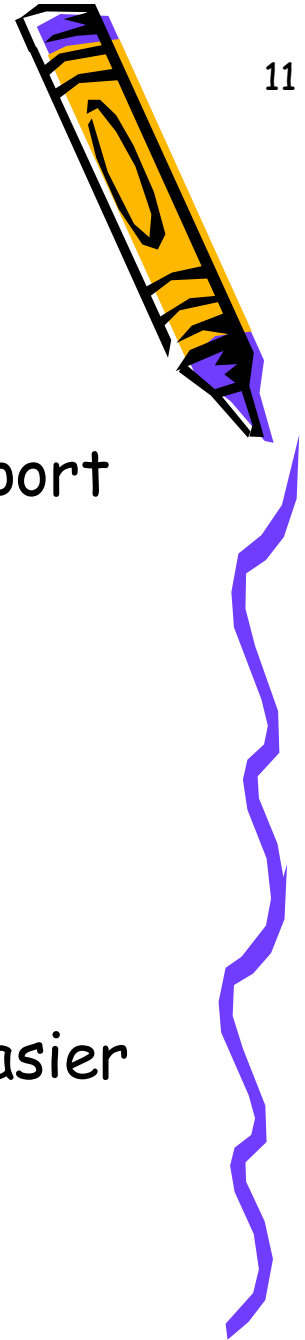

# JDeveloper 9i...

- 100% pure Java
  - Supports Unix/Linux, windows
- Oracle goodies
  - Integrated SQL & PL/SQL support
  - Business Intelligence Beans
  - UIX framework for Oracle Browser look&feel
  - Business Components for Java (BC4J)
    - Pattern framework
- *Many* wizards
- Partial UML modelling support
  - Currently 2 diagram types
    - Class and activity
    - ...more to come
  - Groks BC4J

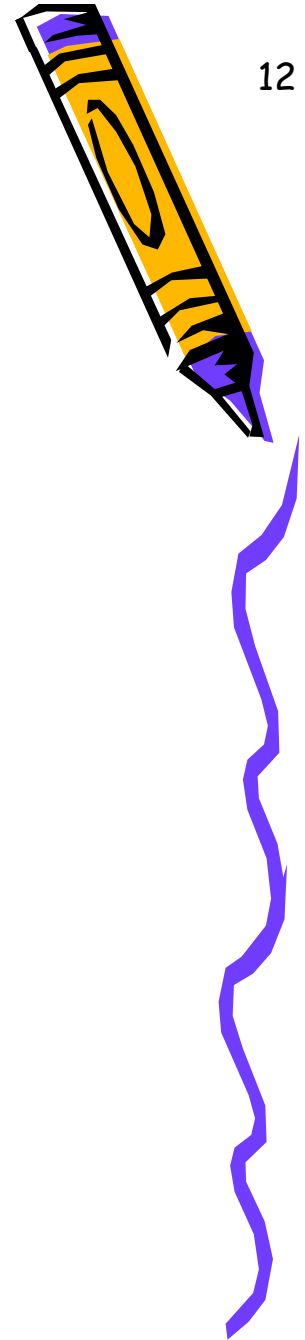

# JDeveloper 9i...

- XML
  - Schemas, XSL, XHTML
  - WebServices
- Extensive 2-tier development support
- Integrated debugging
- Integrated profilers and CodeCoach
- Support for WebDAV and source-code management
- Support for J2EE
- Others
  - Ant/Struts/JUnit/Jalopy/etc...
- And more...and more...and more....

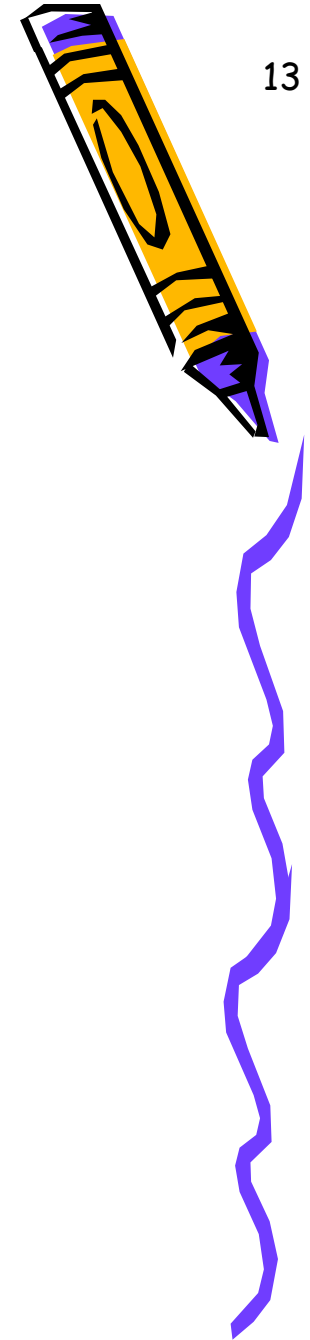

# 'Plain' J2EE

- Not really where the fun is
  - A capable IDE; lots of wizards, etc.
- Oracle9iAS Containers for J2EE (OC4J)
  - Now (JDeveloper 9i 9.0.3) supporting J2EE 1.3.1
- Can target other AppServers
  - OC4J/JBoss/WebLogic 6.x/7
    - Has been a bit buggy...
- End-to-end Development/Deployment support
- Servlets/JSPs/Taglibs
- EJBs
  - Plain J2EE Session EJBs
  - CMP/BMP Entity EJBs
    - EJB 1.1/2.0 variants
    - Top-down development of new functionality or bottom-up mapping to existing persistent data
  - Message Driven Beans

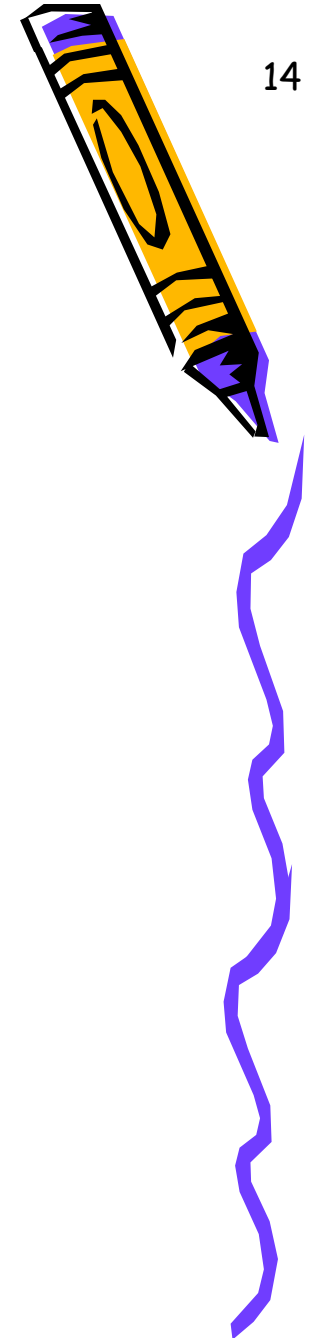

# 'Plain' J2EE...

- Wizard wonderland...

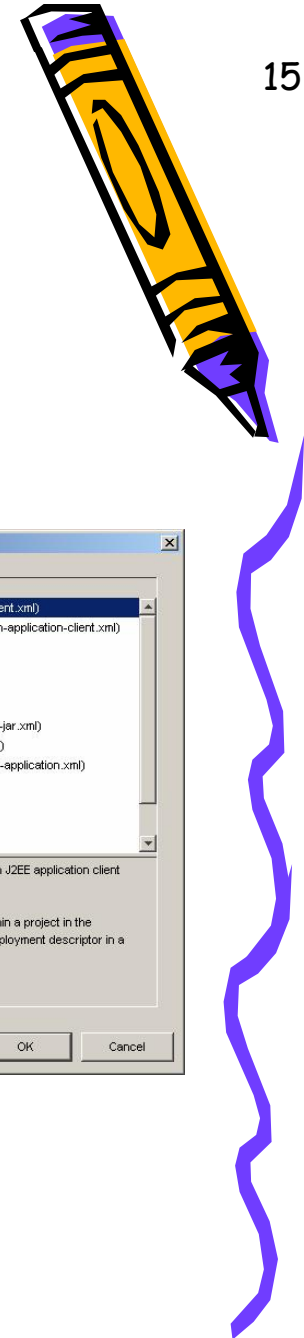

The image displays four overlapping 'New' dialog boxes from an IDE, illustrating the complexity of creating a 'Plain' J2EE application. Each dialog shows a tree view of categories and a list of items.

- Top-left dialog:** Shows 'Enterprise JavaBeans (EJB)' selected in the Business Tier. The 'Items' list includes 'EJB Deployment Descriptor (ejb-jar.xml)', 'EJB Deployment Descriptor for JBoss (jboss.xml)', 'EJB Deployment Descriptor for OC4J (orion-ebj-jar.xml)', 'EJB Deployment Descriptor for WebLogic (weblogic-ebj-jar.xml)', 'Entity Bean', 'Entity Beans from Tables -- Container-Managed Persistence', 'Message Driven Bean', and 'Session Bean'.
- Middle-left dialog:** Shows 'Enterprise JavaBeans (EJB)' selected. The 'Items' list includes 'Business Components Package', 'EJB Application Module', 'EJB Entity Facade', 'EJB Finder View Link', and 'EJB Finder View Object'.
- Bottom-left dialog:** Shows 'JavaServer Pages (JSP)' selected in the Web Tier. The 'Items' list includes 'JSP Document', 'JSP Page', 'JSP Tag', and 'Web Bean'.
- Right dialog:** Shows 'Application Client Deployment Descriptor (application-client.xml)' selected. The 'Items' list includes 'Application Client Deployment Descriptor for OC4J (orion-application-client.xml)', 'Data Sources Descriptor for OC4J (data-sources.xml)', 'EJB Deployment Descriptor (ejb-jar.xml)', 'EJB Deployment Descriptor for JBoss (jboss.xml)', 'EJB Deployment Descriptor for OC4J (orion-ebj-jar.xml)', 'EJB Deployment Descriptor for WebLogic (weblogic-ebj-jar.xml)', 'J2EE Application Deployment Descriptor (application.xml)', 'J2EE Application Deployment Descriptor for OC4J (orion-application.xml)', 'Java Web Start (.JNLP) Files', 'Java Web Start (.JNLP) Files for JClient', 'JSP Tag Library Descriptor (taglib.tld)', and 'Web Deployment Descriptor (web.xml)'. A note at the bottom states: 'Creates a template to include deploy-time settings in the Sun J2EE application client deployment descriptor, application-client.xml. To enable this option, you must select a project or a file within a project in the Navigator. You may have only one application-client.xml deployment descriptor in a project.'

# BC4J Components

- Here's where the real fun/value is...

*"A Helping Hand in Every Tier"*

- Based on Java Enterprise Blueprints
  - Provides the 'glue' that a system needs
  - Session façade, fast-lane reader, page-by-page iterator, value object, etc.
  - Plus various additions

*"A programming tool that allows you to build reusable modules and business components can dramatically reduce your development times, letting you bring new applications to market faster.*

*That's the kind of tool Oracle's Business Components for Java (BC4J) is."*

*"...a carefully-architected blend of J2EE technologies. ...At its core, BC4J is a metadata-driven Data Access Objects framework."*

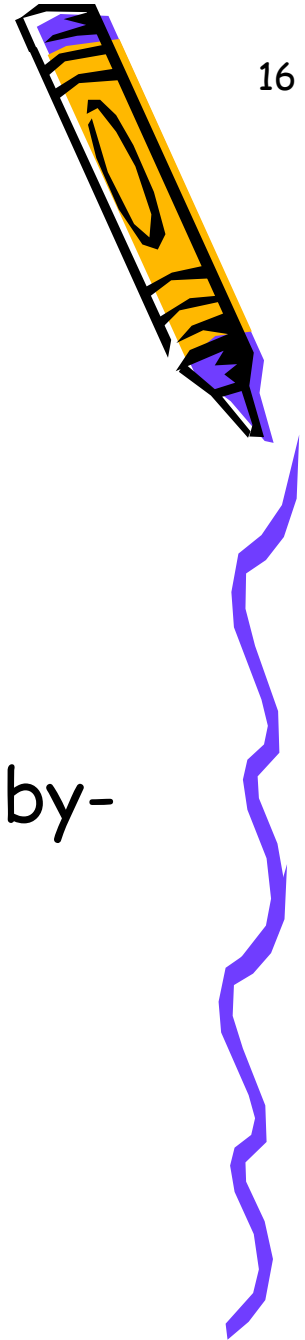



# BC4J Components...

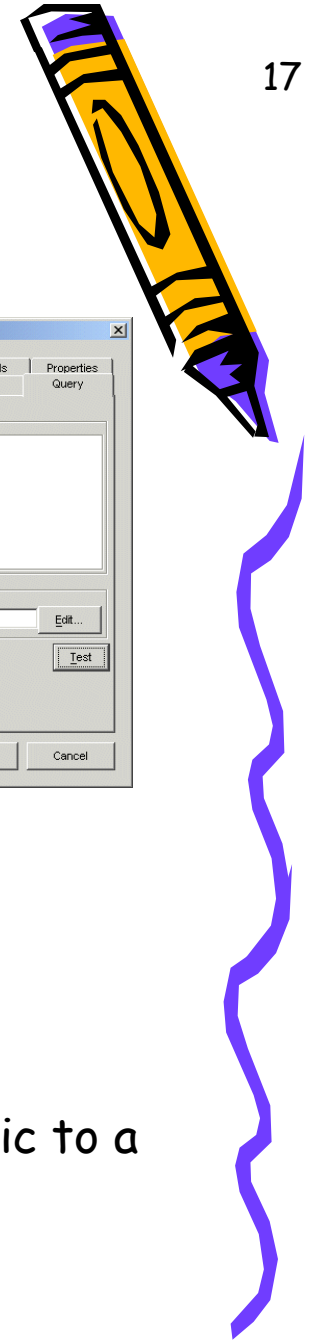

- Five basic interrelated framework components:
  - Entity Objects
    - Lightweight Data Access Objects
  - View Objects
    - Companion fully-updatable DAOs that assist in joining, filtering, projecting, and sorting
    - configurable
  - Associations
  - View Links
    - Build hierarchies of master-detail queries
  - Domain
    - Ease manipulation of complex data types
  - Application Modules
    - Provide a Model/View/Controller application object
    - Can contain both process and business logic that is specific to a particular application task
    - Wrap access to the other data access objects in the framework

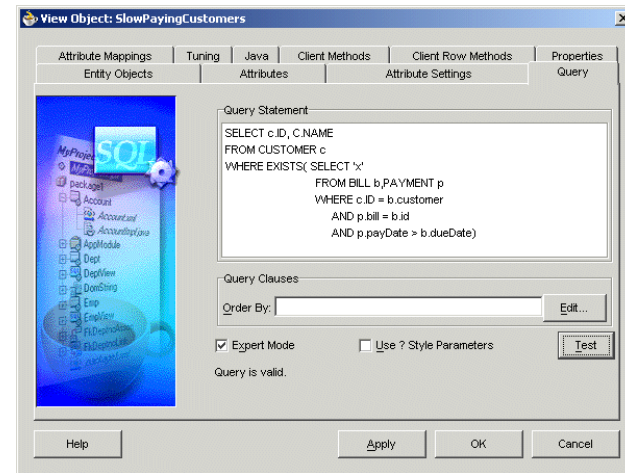

# BC4J Components...

- Each component has 2 parts: XML deployment/configuration metadata and Java object code
- Can deploy to EJBs/CORBA/DAO/...
  - Tries to remain AppServer agnostic
    - DAO/EJB1.1 preferred

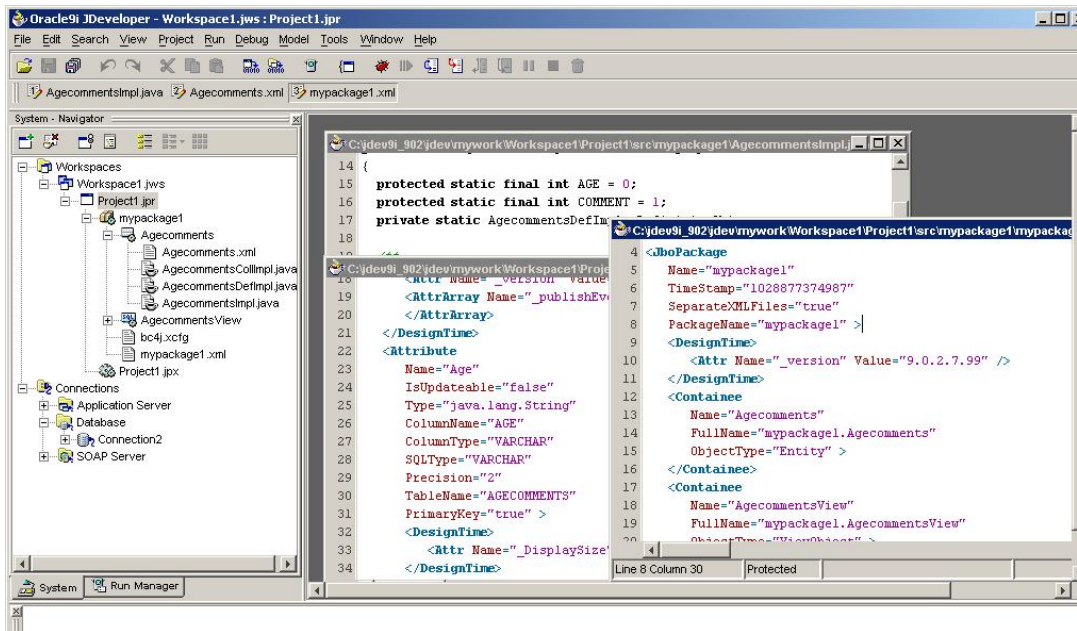

*"Over 20 of Oracle's own internal applications development teams and many external customers count on BC4J to help them deliver highly functional, well-performing J2EE applications with JSP, Servlet, Swing, and XML Web Services interfaces in record time."*

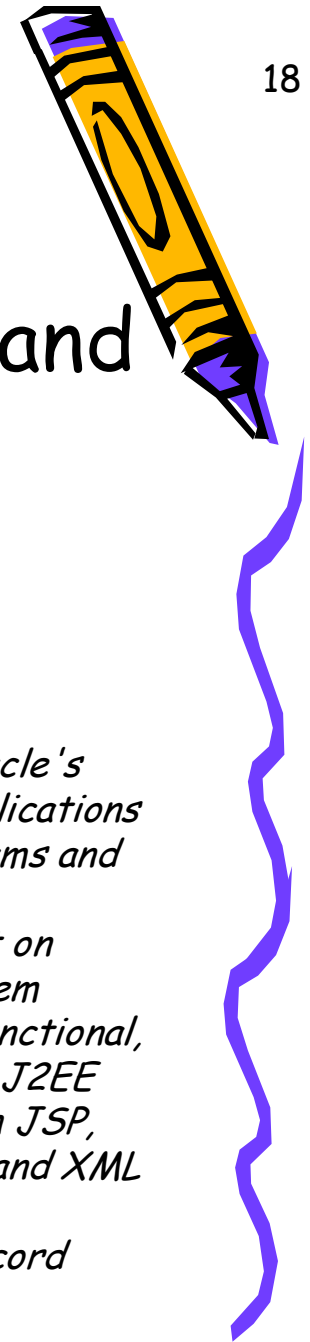

# BC4J Components...

- Wizard wonderland...take 2...

The image displays four overlapping screenshots of the Oracle BC4J Entity Object Wizard, illustrating the configuration process for an entity object.

- Entity Object Wizard, Step 1 of 4: Name**: Shows the configuration for the entity name and database objects. The Name is "Agecomments", Package is "mypackage1", and Schema Object is "APP.AGECOMMENTS".
- Entity Object Wizard, Step 2 of 4: Attributes**: Shows the selection of attributes for the entity. The attributes "Age" and "Comment" are listed.
- Entity Object Wizard, Step 3 of 4: Attribute Settings**: Shows the configuration for the "Age" attribute. It is set as a String type, Persistent, Primary Key, and Queriable. The Database Column is "AGE" with type "VARCHAR(2)".
- Entity Object Wizard, Step 4 of 4: Java**: Shows the configuration for the Java classes and methods. The Entity Definition Class is "AgecommentsDefImpl", Entity Collection Class is "AgecommentsCollImpl", and Entity Object Class is "AgecommentsImpl". The "Generate Java File" checkbox is checked for all three classes. The "Generate Methods" section is also checked for "Accessors", "Data Manipulation Methods", "Validate Method", "Create Method", and "Remove Method".

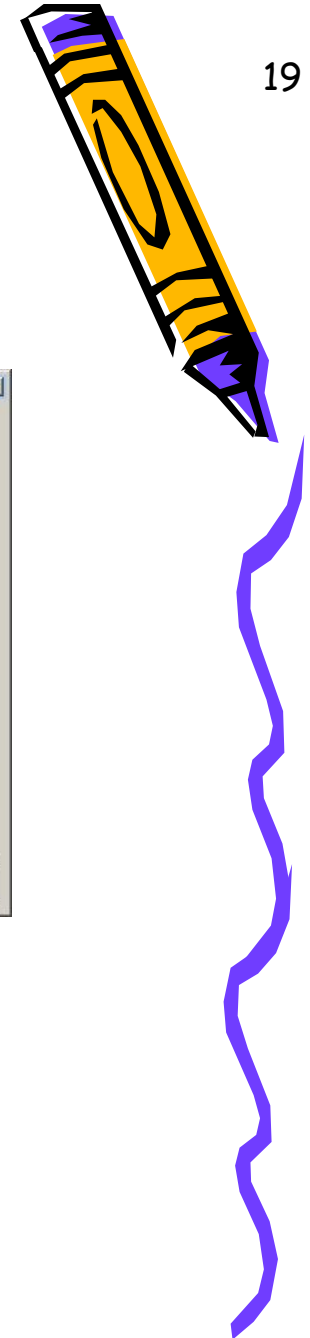

# BC4J Components...

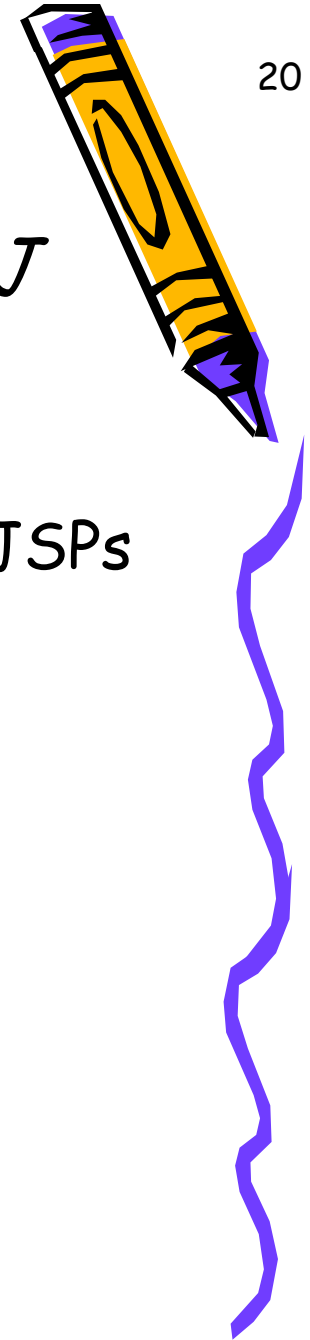

- Also provides framework-oriented *BC4J JSP application*
  - Pre-canned JSP solutions
  - Template-driven approach for data-bound JSPs
    - Bind to various BC4J pre-canned components
    - Bind to AppModule

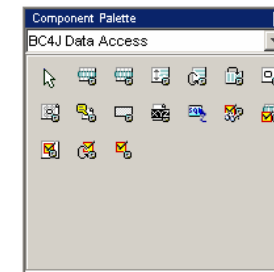
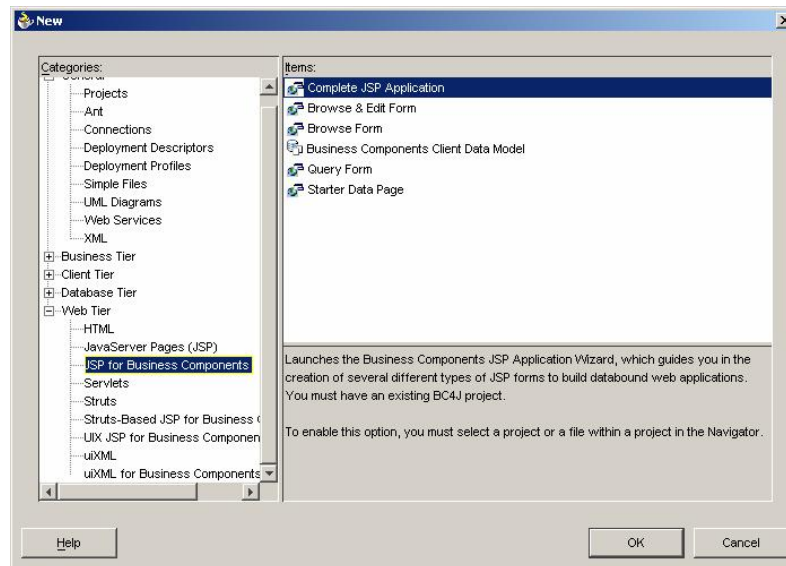

# BC4J Value Judgement

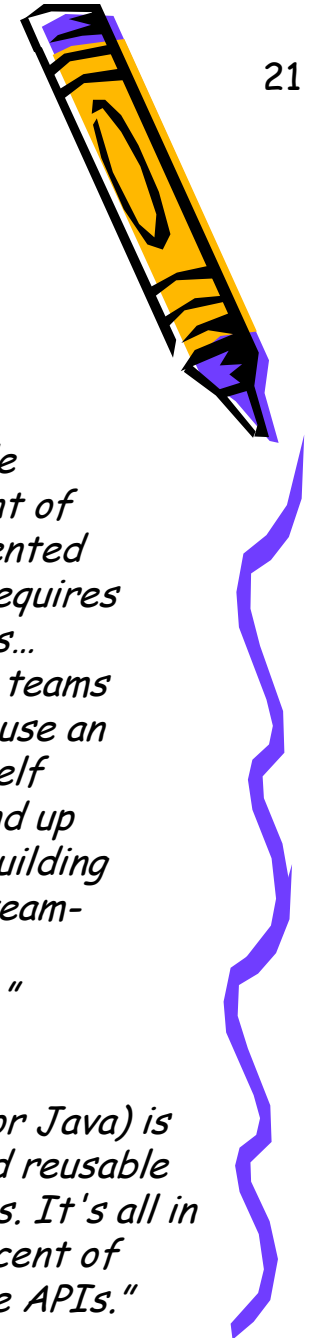

- Whether to "buy in" to all these BC4J/Wizards/goodies...
  - "ay, there's the rub..."

*"There are a few areas where JDeveloper can lock unsuspecting developers into an Oracle-only solution (the Web Services integration frameworks and the Business Objects support both require Oracle provided libraries), but there's nothing inherently wrong with a server vendor making it easy to use their servers."*

InfoWorld rates BC4J as having no 'cons'



*"I'd like to see Oracle submit a BC4J JSR or utilize another mechanism to guarantee that I won't be locked into a vendor-proprietary solution if I use the BC4J framework."*

*"Large scale development of object-oriented software requires frameworks... Inevitably, teams that don't use an off-the-shelf offering end up gradually building their own team-specific framework."*

*"BC4J (Business Components for Java) is very hot stuff. It lets you build reusable components like blocks in Forms. It's all in JDeveloper and is very reminiscent of Designer module APIs and table APIs."*

(Designer slated to go away in 2004)

# JClient

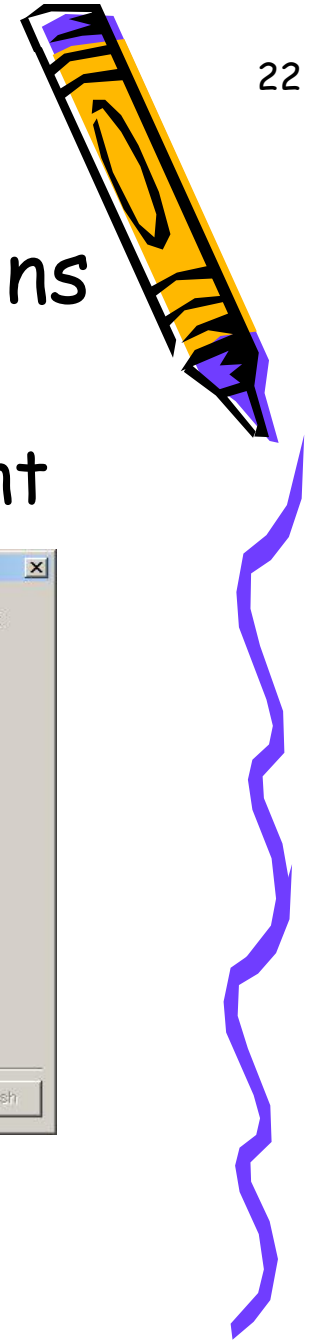

- Framework for Java client applications
  - Wizards generate code to bind Swing components to BC4J business component data sources

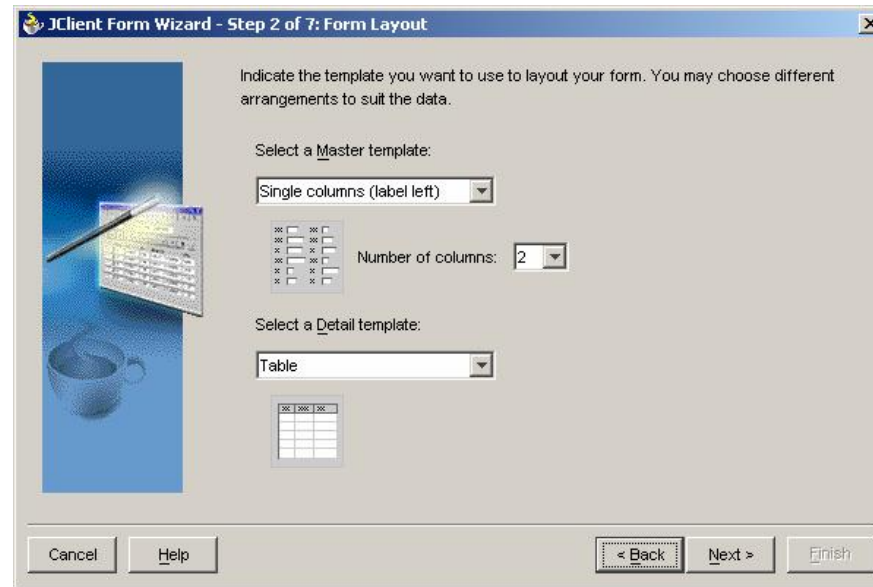

- Can be packaged for Java Web Start
- Handles 'smarts' like lazy load/update...

# UML Modelling/Generation

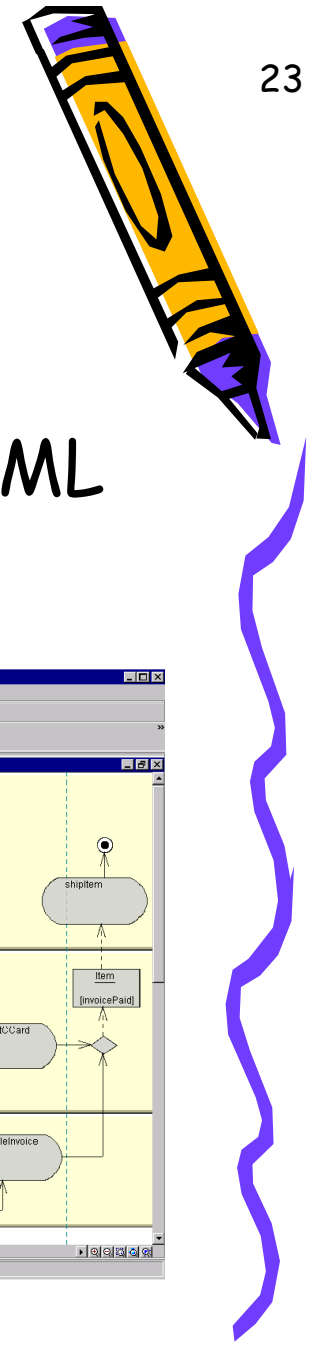

- Supports class and activity diagrams
  - Generates plain J2EE or BC4J code
- Supports XMI for exchange with other UML tools

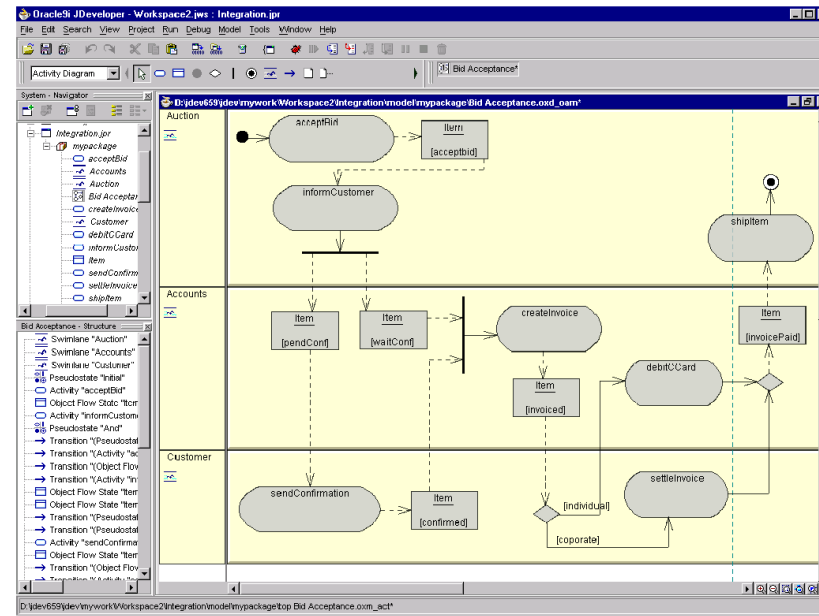
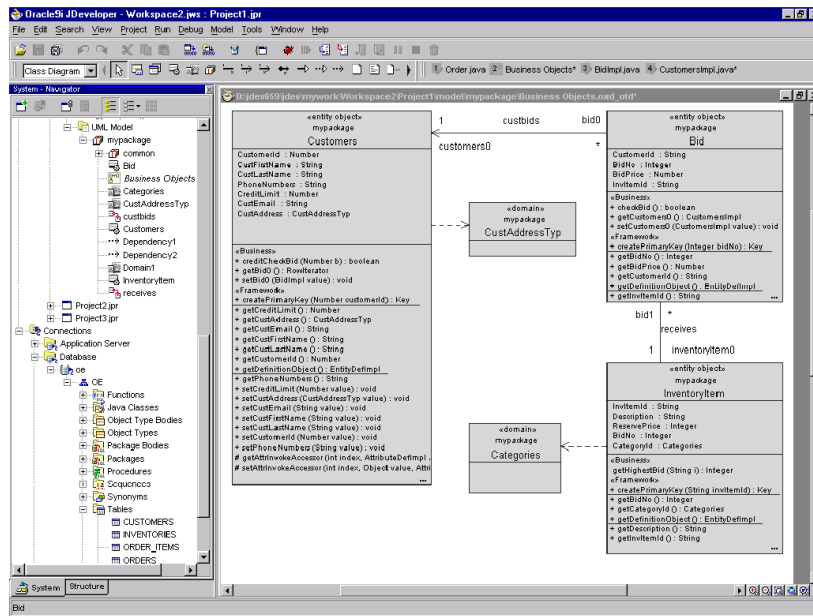

# WebServices

- Being introduced into the J2EE through J2EE 1.4 and JSR 109
- JDeveloper can 'wrap' most components as WebServices
  - BC4J & EJBs...
  - Also PL/SQL
- Oracle provides a WebServices tag library with OC4J to make life easier
  - Can use with JDeveloper, obviously

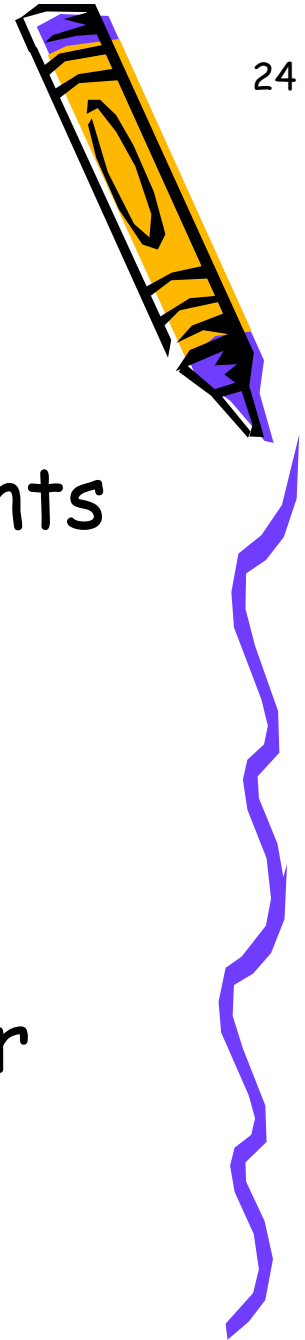



# WebServices...

- Wizard wonderland...take 3...

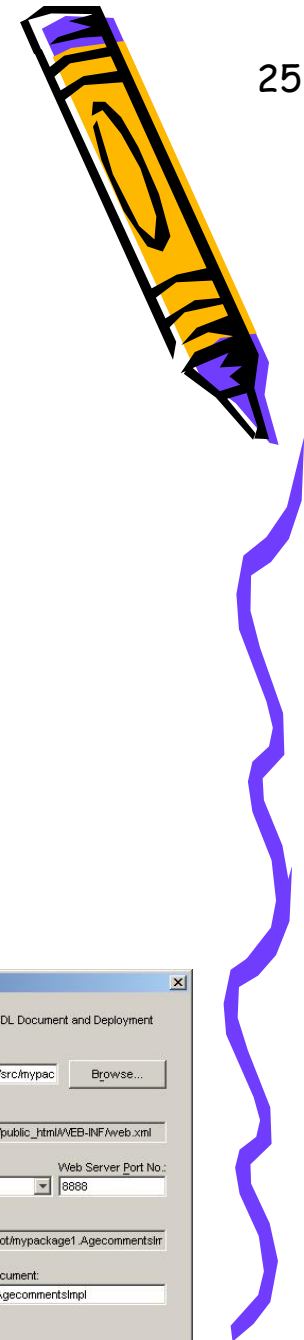

The screenshot shows the Oracle9i JDeveloper IDE with the following components:

- System Navigator:** Shows a project structure with 'mypackage1' containing 'Agecomments' and 'AgecommentsView'.
- WSDL Editor:** Displays the content of 'AgecommentsImpl.wsdl', including XML headers and a `<definitions>` section with a `AgecommentsImpl` type definition.
- Web Service Publishing Wizard - Step 1 of 3:** 'Web Service Class, Name and Platform'. The 'Class' field is set to 'mypackage1.AgecommentsImpl' and the 'Deployment Platform' is 'Oracle J2EE Web Services'.
- Web Service Publishing Wizard - Step 2 of 3:** 'Exposed Methods'. A list of methods is shown, with 'getAge()' and 'getComment()' selected.
- Web Service Publishing Wizard - Step 3 of 3:** 'File Locations'. Fields for 'WSDL Document URL', 'Deployment Descriptor File URL', 'Application Server Endpoint', and 'Web Service Endpoint' are visible.
- Messages Log:** Shows the completion of WSDL generation: 'Generating Deployment Descriptor', 'Generating web.xml entries', and 'Generation complete.'

# WebServices...

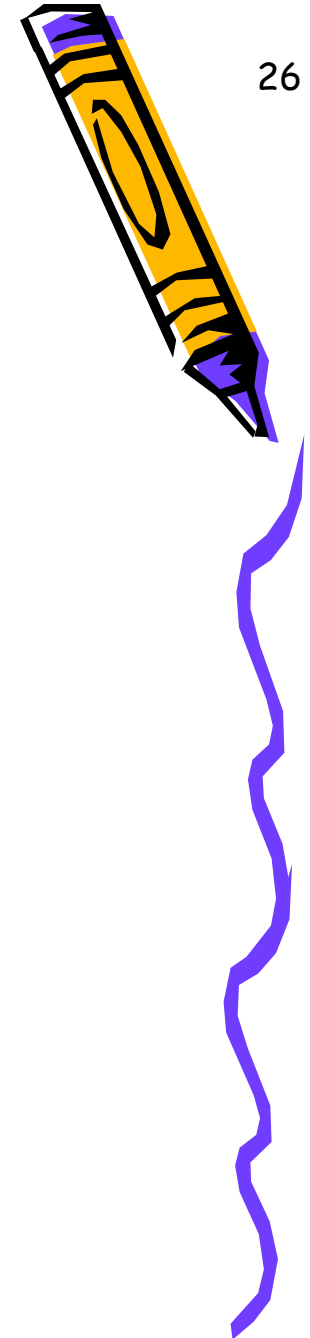

- Example: check an item on ebay

```
<%@ page contentType="text/html"%>
<%@ taglib uri="http://xmlns.oracle.com/j2ee/jsp/tld/ws/wstaglib.tld"
      prefix="ws" %>

<HTML>
<HEAD>
<META HTTP-EQUIV="Content-Type" CONTENT="text/html; " >
</HEAD>
<BODY>
<% String itemID = request.getParameter("itemID"); %>
<ws:webservice id="ebay"
  wsdlUrl="http://www.xmethods.net/sd/2001/EBayWatcherService.wsdl"
  binding="eBayWatcherBinding"
  soapLocation="http://services.xmethods.net:80/soap/servlet/rpcrouter"
  scope="page">
  <ws:property name="http.proxyHost" value="www-proxy.us.oracle.com"/>
  <ws:property name="http.proxyPort" value="80"/>
</ws:webservice>
<ws:invoke id="price" webservice="ebay" operation="getCurrentPrice">
  <ws:part name="auction_id" value="<%=itemID%>"/>
</ws:invoke>
<B>Action price for eBay Item # <%=itemID%> is :</B>
<P>
&#x20;<%= price%>@<%=new java.util.Date()%>
</P>
</BODY>
</HTML>
```

# PL/SQL WebService

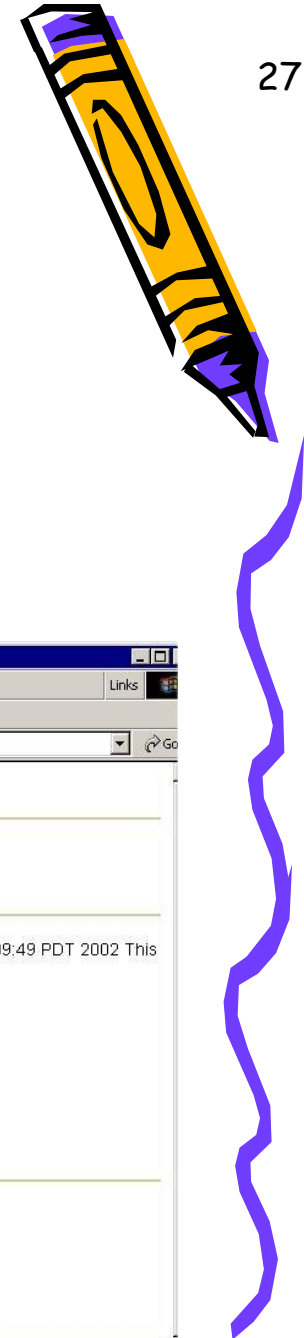

- JDeveloper makes it easy to expose PL/SQL as a WebService

The screenshot shows the 'New' dialog box in JDeveloper. The 'Categories' pane on the left is expanded to 'Web Services'. The 'Items' pane on the right lists several options, with 'PL/SQL Web Service' selected. In the foreground, the 'PL/SQL Web Service Publishing Wizard - Step 2 of 3: Program Units' dialog is open. It features a graphic of a gear and a document with a URL. The 'Select the program units which you want to expose' list includes:

- PROCEDURE ADDEMP
- PROCEDURE CHANGEMP
- FUNCTION GETADDR
- FUNCTION GETEMP(IN)
- FUNCTION GETEMP(IN)
- PROCEDURE REMOVEEMP

The screenshot shows a Microsoft Internet Explorer browser window displaying the 'Company endpoint' page. The address bar shows the URL: `http://127.0.0.1:8868/PLSQL-PLSQL-context-root/oracle9i.CompanyWebService`. The page content includes:

### Company endpoint

For a formal definition, please review the [Service Description \(rpc style\)](#).

### Company service

Generated by the Oracle9i JDeveloper PL/SQL Web Service Generator Date Created: Wed Aug 07 12:09:49 PDT 2002 This class is a generated wrapper for the PL/SQL package COMPANY. DO NOT EDIT.

The following operations are supported.

- [getemp](#)
- [removeemp](#)
- [addemp](#)
- [getaddress](#)

### oc4j client

The java proxy is packaged in a jar either as classes or sources files.

- [Proxy Jar](#)
- [Proxy Source](#)

# Extensions Exchange

28

- <http://otn.oracle.com/products/jdev/htdocs/partners/addins/exchange/content.html>
- Lots of user-contributed/commercial/Oracle-developed extensions
  - Often concerned with bringing the Open Source world to JDeveloper
    - JUnit, Jalopy, Ant, Struts, etc.
  - Sometimes rolled into JDeveloper itself

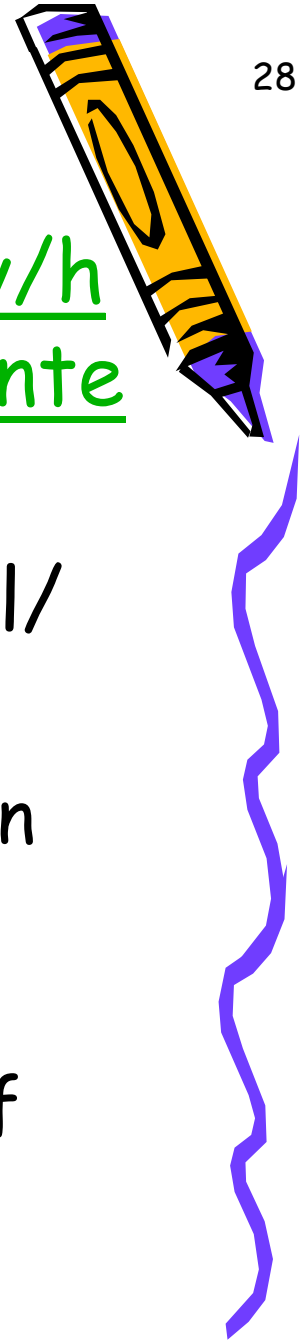

# Cat Among Pigeons Time

- XDoclet
  - Very appealing
  - A generic Java tool that lets you create custom Javadoc @tags and based on those @tags generate source code or other files (such as xml deployment descriptors)
  - "Continuous Reconfiguration"
    - Don't have to worry about outdated deployment meta-data whenever you touch the code
  - Integrated into the build process with Ant

*"This free open source solution can simplify your EJB development, allowing you to work just with a bean class and have the interfaces and descriptors generated for you. This framework is growing, and isn't just for EJBs."*

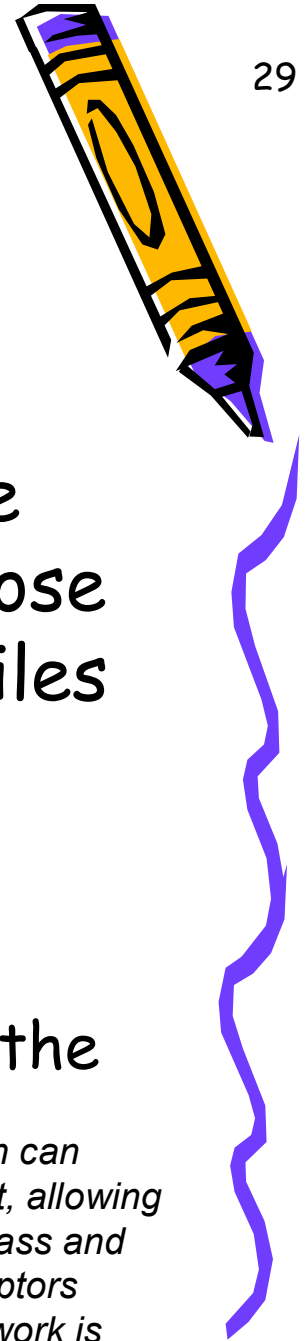

# XDoclet...

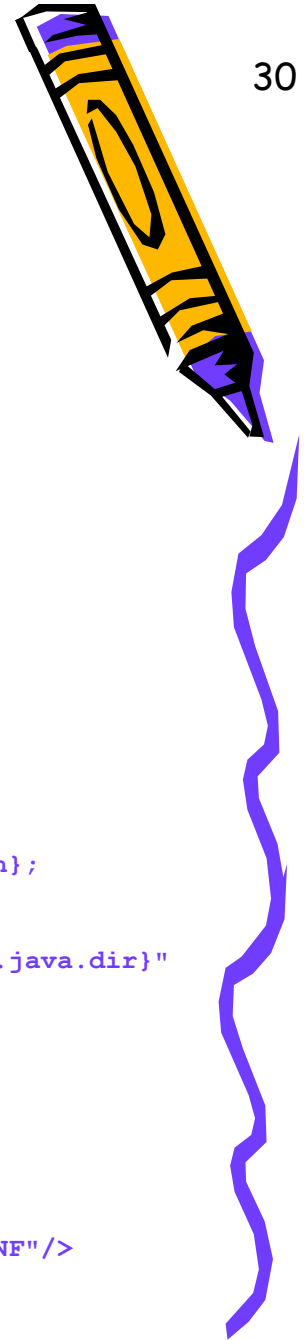

```
/**
 * @ejb:bean type="Stateless"
 *          name="MyXDocletEJB"
 *          jndi-name="the-ejb-name"
 *          display-name="The EJB"
 *
 * @ejb:env-entry name="parameter" type="java.lang.String" value="some.data"
 */
public class EJB implements SessionBean {

    /**
     * @ejb:interface-method view-type="remote"
     */
    public void aMethod(String someParam) throws RemoteException {
```

```
<target name="ejbdoclet" depends="prepare">

    <taskdef name="ejbdoclet"
             classname="xdoclet.ejb.EjbDocletTask"
             classpath="${java.class.path};${xdoclet.jar.path};
             ${log4j.jar.path};${ant.jar.path}"/>

    <ejbdoclet sourcepath="${java.dir}" destdir="${generated.java.dir}"
              ejbspec="2.0">

        <fileset dir="${java.dir}">
            <include name="**/EJB.java" />
        </fileset>

        <remoteinterface/>
        <homeinterface/>
        <deploymentdescriptor destdir="${build.dir}/ejb/META-INF"/>
        <orion destdir="${build.dir}/ejb/META-INF" />

    </ejbdoclet>
</target>
```

# The Future for JDeveloper

- Version 9.0.3 (preview) now available for download
  - Improved/Updated support for
    - J2EE
      - JSPs/Servlets
      - EJBs
    - Struts
    - UML
    - Ant
    - WebServices
    - CVS
    - XML
  - Looking to be (almost) the best thing since sliced bread 😊
    - Already very solid

*“JDeveloper is Oracle's strategic development tool, and as such will continue to evolve quickly, especially in the modeling field.”*

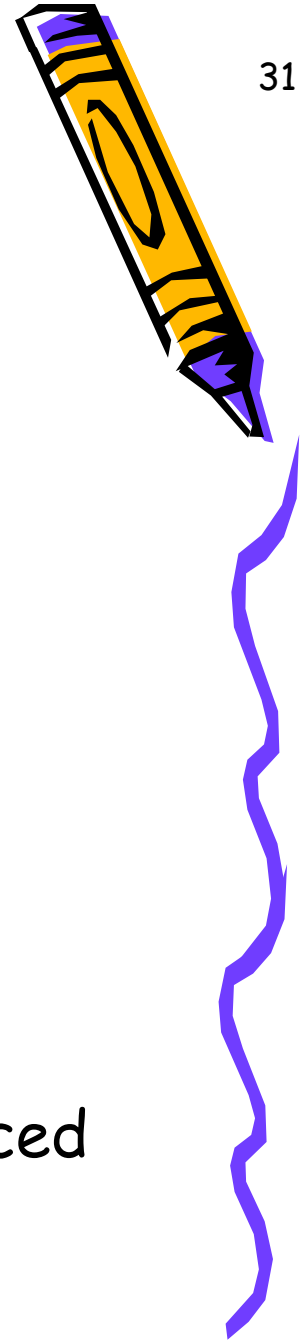

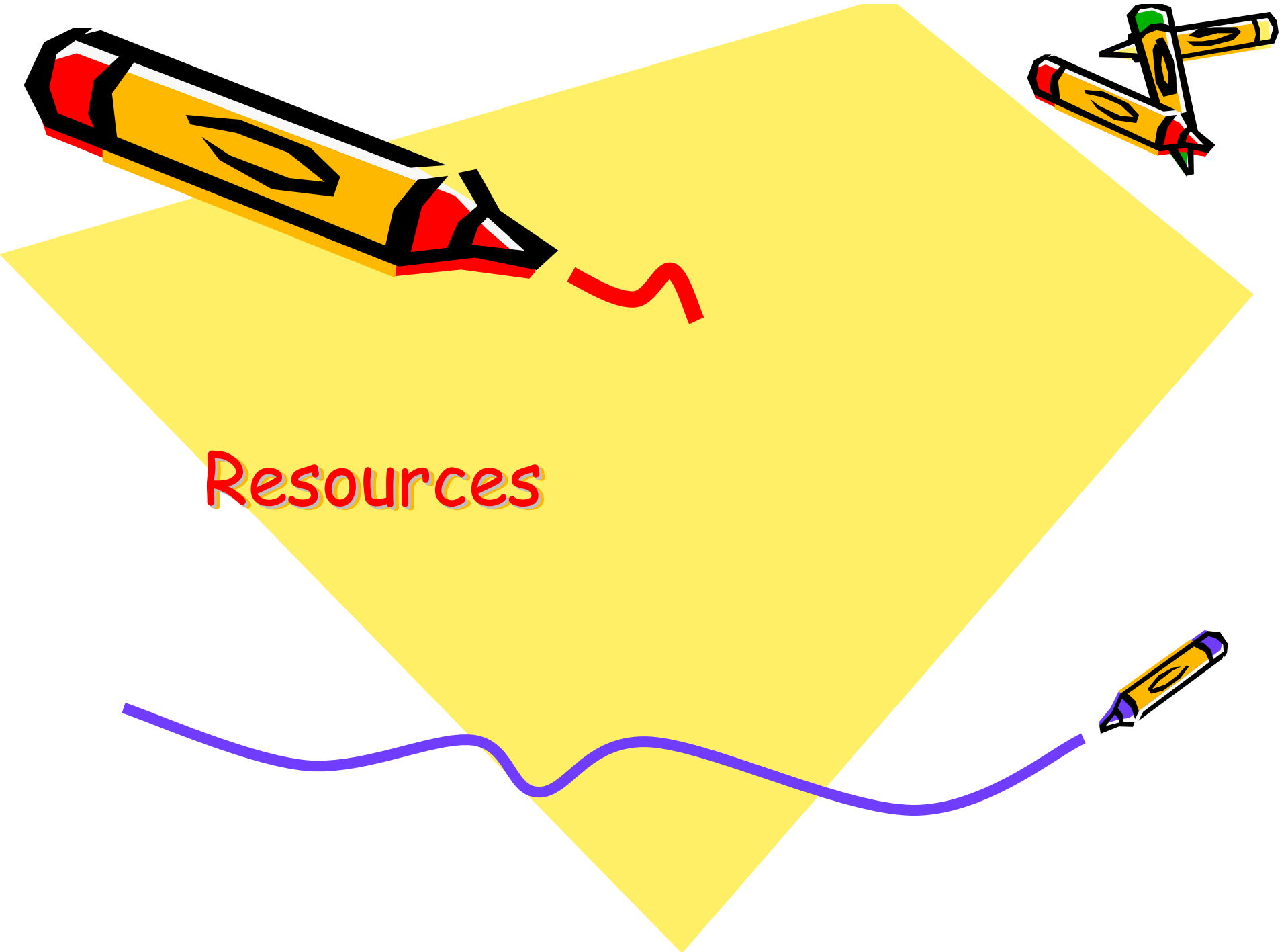

Resources



# Resources

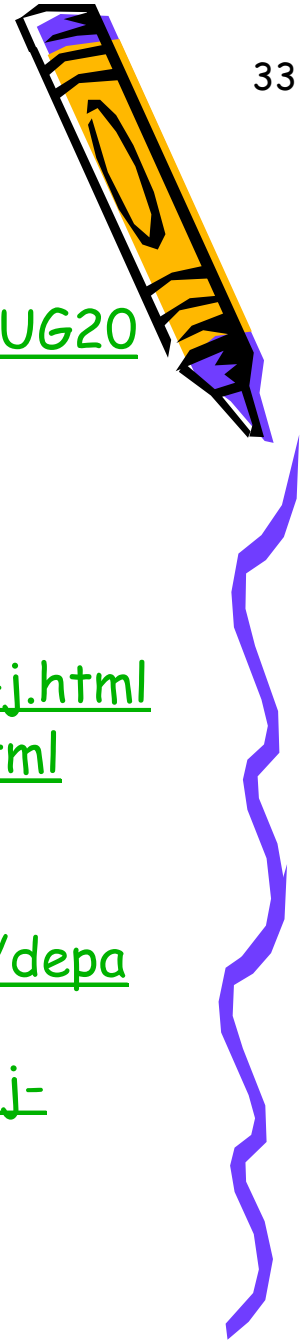

- These slides:
  - <http://www.transentia.com.au/material/BrisbaneAUSOUG2002.pdf>
- Where to find more...
  - <http://java.sun.com/blueprints/enterprise/index.html>
  - <http://otn.oracle.com/products/jdev/>
  - [http://otn.oracle.com/products/jdev/htdocs/j2ee\\_bc4j.html](http://otn.oracle.com/products/jdev/htdocs/j2ee_bc4j.html)
  - <http://technet.oracle.com/products/ids/daily/feb12.html>
  - <http://www.dulcian.com/papers>
    - *Don't be a Muggle! Be a JDeveloper 9i Wizard!*
  - [http://www.fawcette.com/javapro/2002\\_05/magazine/departments/productreviews/default\\_pf.asp](http://www.fawcette.com/javapro/2002_05/magazine/departments/productreviews/default_pf.asp)
  - <http://www-106.ibm.com/developerworks/java/library/j-webstart/?dwzone=java>
  - <http://xdoclet.sourceforge.net>
  - <http://java.about.com/cs/ides>